

UNIWEB INC.

Installation Instructions

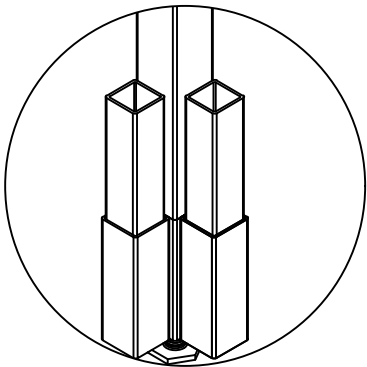

ENLARGED VIEW

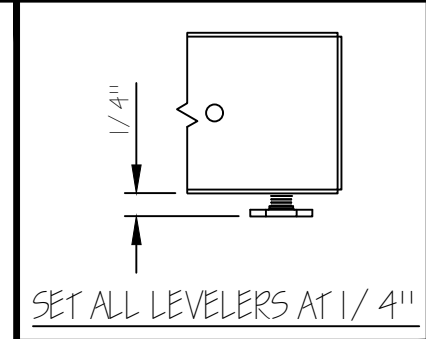

SET ALL LEVELERS AT 1/4"

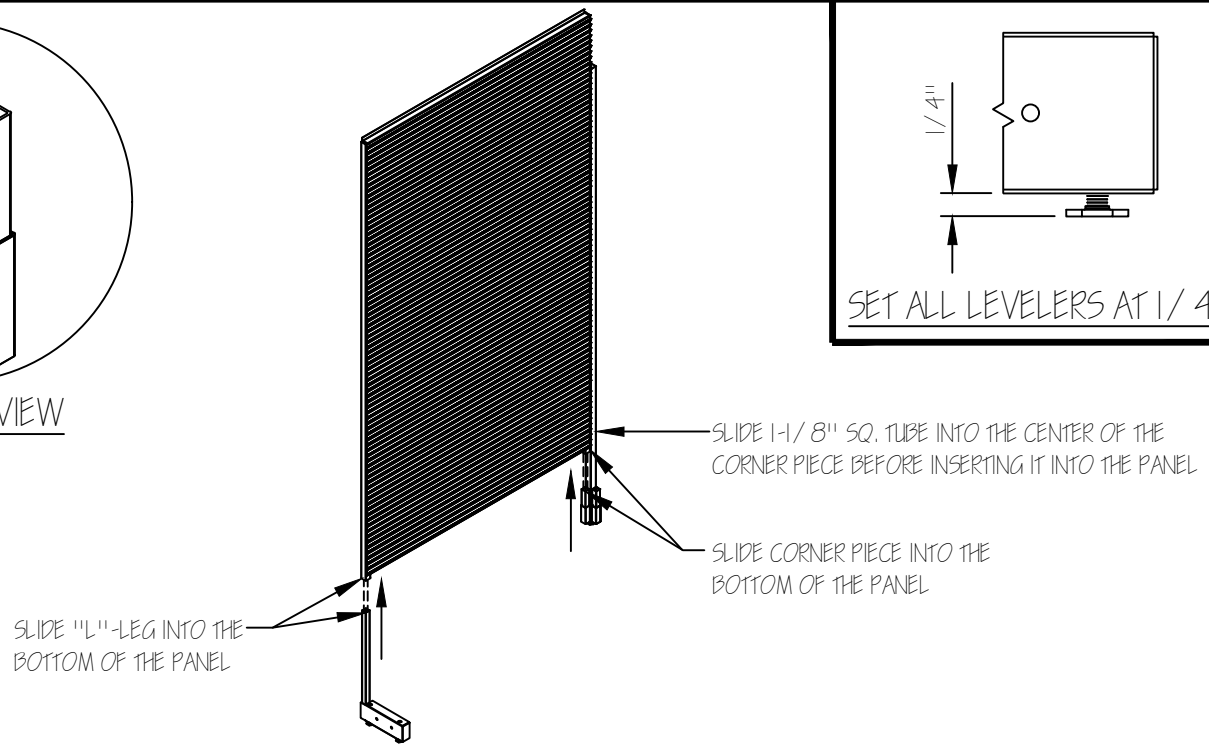

Step 1:

Slide the "L"-leg and Corner Piece into the bottom of the Uniweb panel, While the panel is laying shape up on the floor

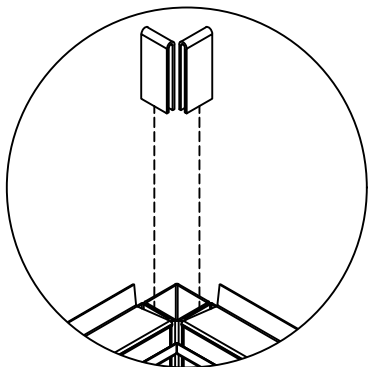

ENLARGED VIEW

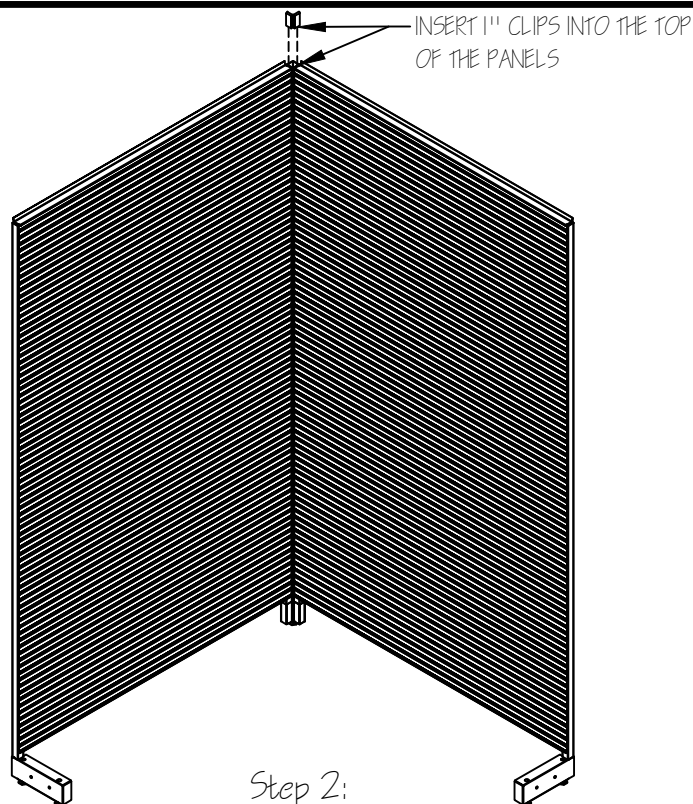

Step 2:

Insert 1" clips into the top of the panels and into the 1-1/8" SQ. tube to connect the panels to the corner

UNIWEB INC.

Installation Instructions

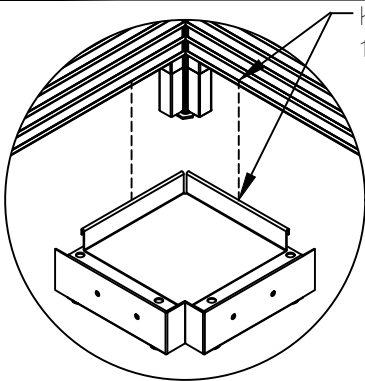

HANG CORNER BASE ONTO
THE CORNER RIBS

ENLARGED VIEW

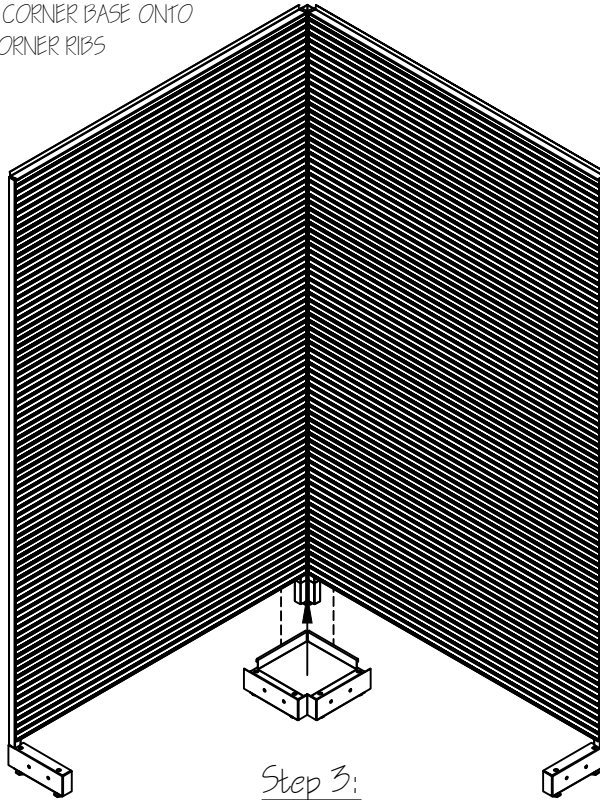

Step 3:

Hang the Corner Base onto the corner ribs. Square the Corner Base up

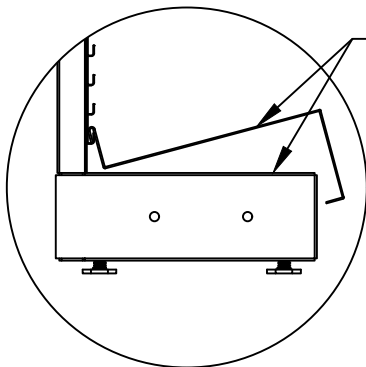

SNAP THE DECKS OVER
THE "L"-LEGS

ENLARGED VIEW

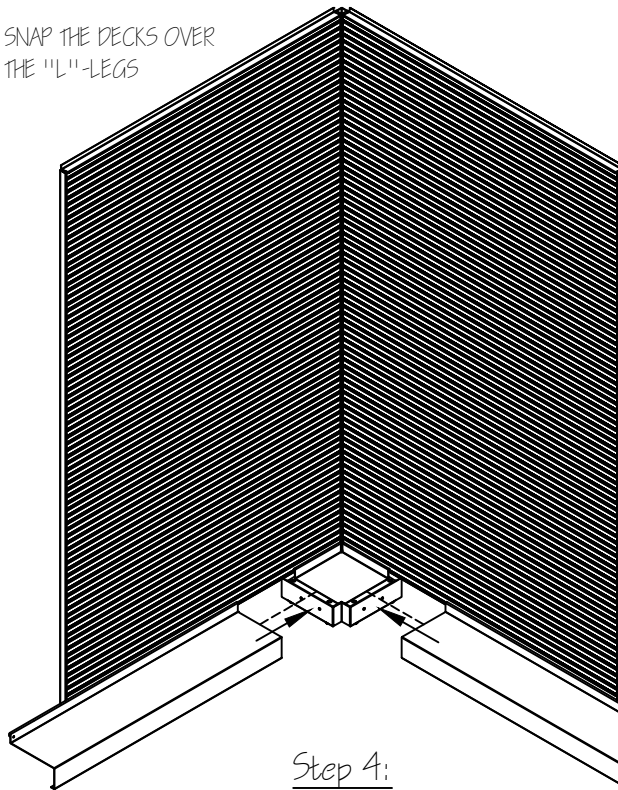

Step 4:

HANG THE DECK ON THE RIB
AND LINE IT UP WITH THE
CORNER BASE

Hook the Metal Deck onto the rib slide or snap the deck onto the "L"-Leg, Then line it up with the Corner Base

UNIWEB INC.

Installation Instructions

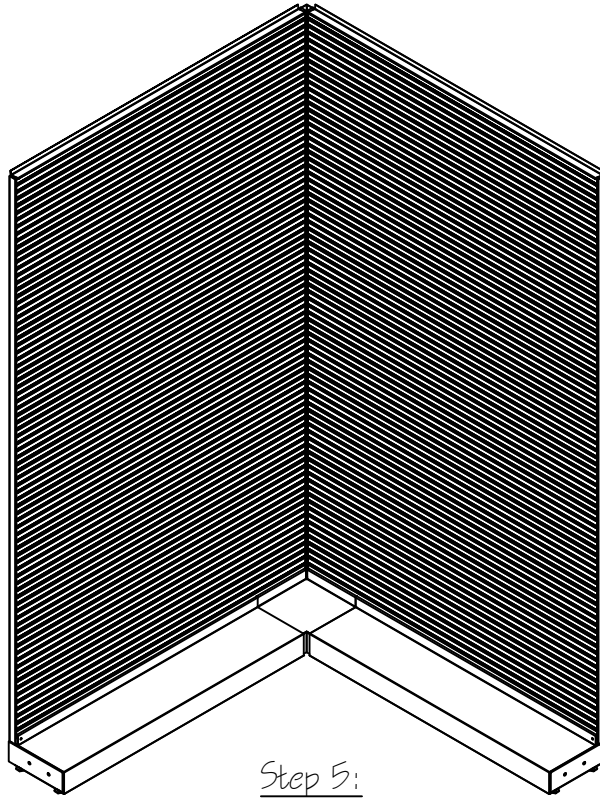

Step 5:
Finished Product

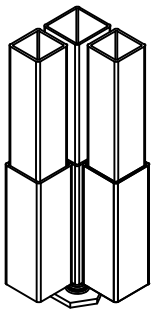

CORNER STUB LEG

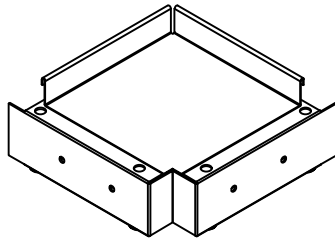

CORNER BASE

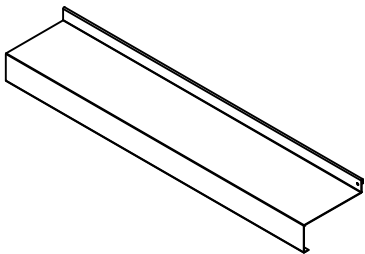

METAL DECK

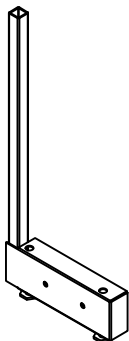

"L"-LEG

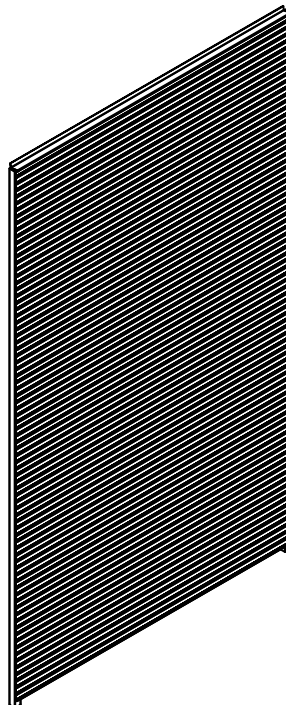

SYSTEM 88 PANEL



CORNER TUBE

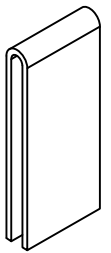

1" CLIP